



GSM ANTENNA

Antenna GSM Mount R36,
PUK, RG174/3m, SMA(m)

AO-AGSM-36S

SECTRON company offers wide portfolio of GSM antennas with various versions differing in shape, level of gain or attachment manner. SECTRON guarantees a compatible connection between antenna and all antenna adaptors produced by SECTRON.



BENEFITS

- Low VSWR
- Omnidirectional – suitable for moving devices
- Anti-vandal design

Technology	GSM
Frequency bands	800/900/1700/1800/1900/2100 MHz
Bandwidth	-
Gain	0 dBi
VSWR	<2.0: 1
Impedance	50 Ohm
Directivity	Omnidirectional
Beam angle	H 360° V 30°
Polarization	Linear
Maximum input power	10 W
Power voltage	-
Dimensions	53 x 32 mm
Weight	80.09 g
Operating temperature	-30 to +90 ° C
Execution	External
Method of attachment	Mounting
Cable type	RG174 / U
The cable length	3 m
Connector type	SMA(m)

DRAWING

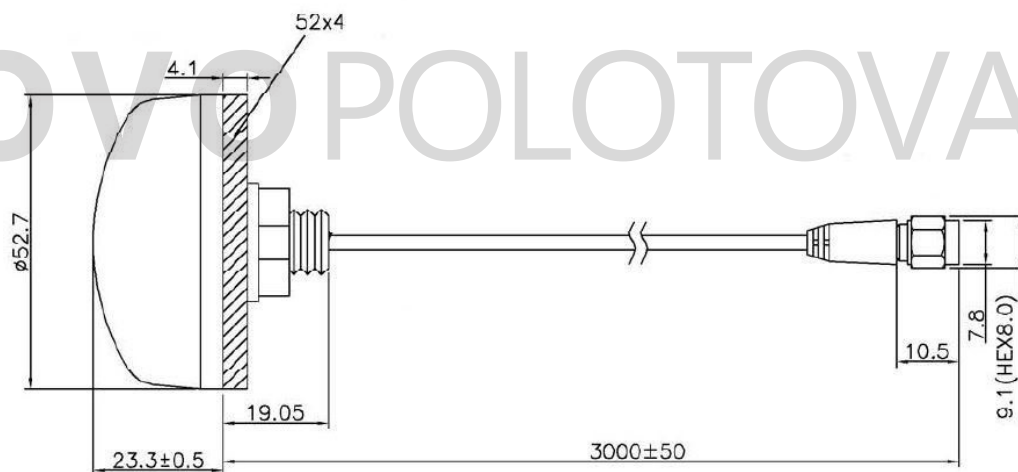

Far-field amplitude 900 MHz -E.nsi

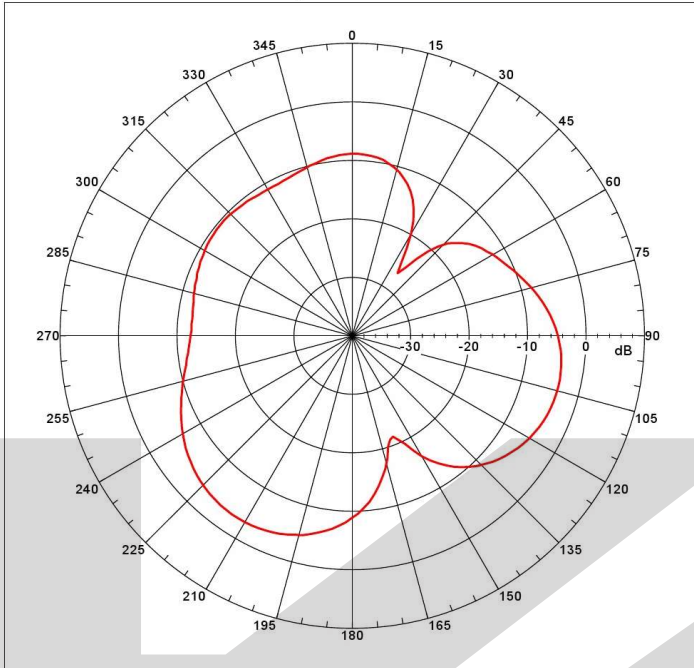

Far-field amplitude 900 MHz -H.nsi

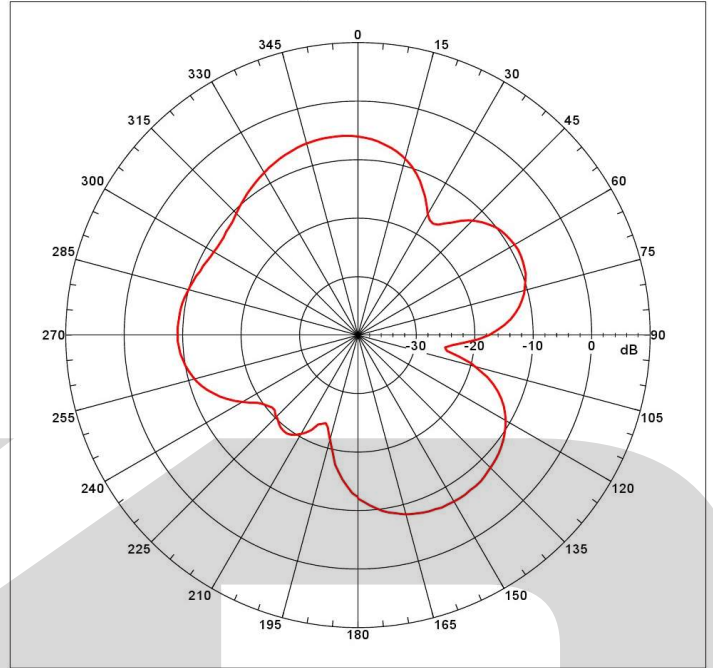

Far-field amplitude 1 800 MHz -E.nsi

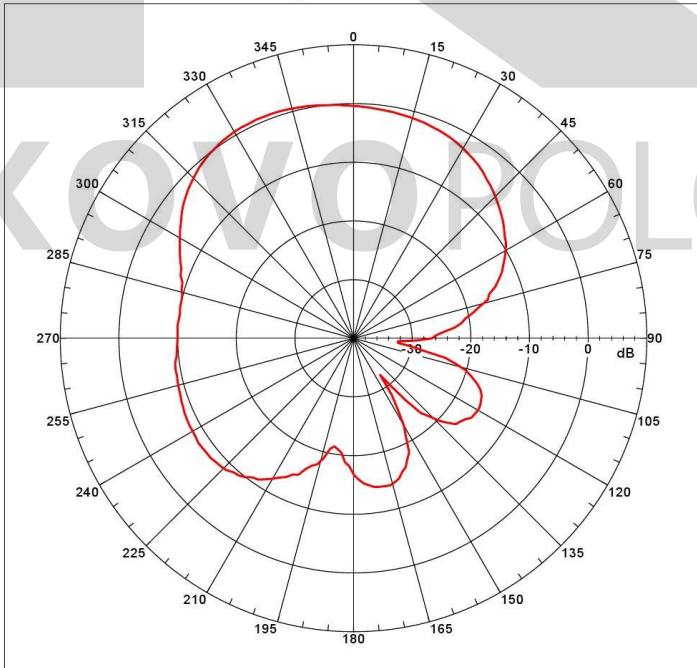

Far-field amplitude 1 800 MHz -H.nsi

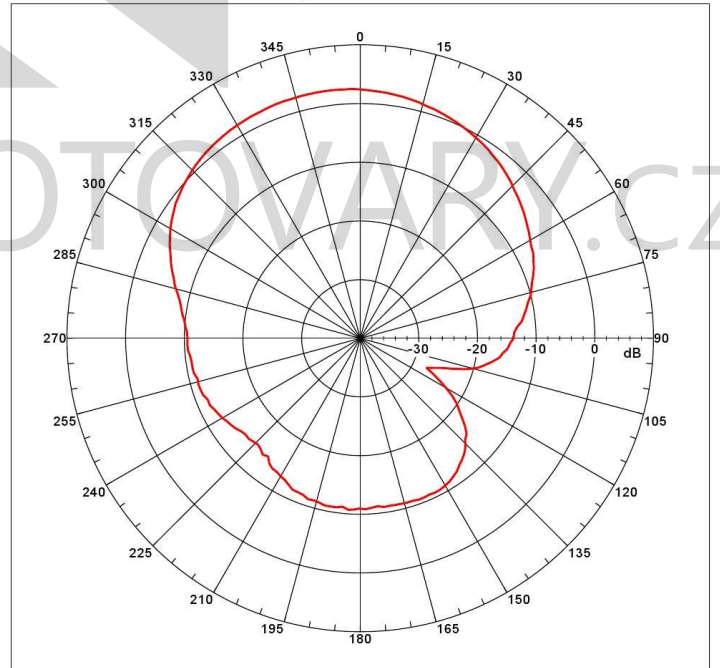

Far-field amplitude 1 900 MHz -E.nsi

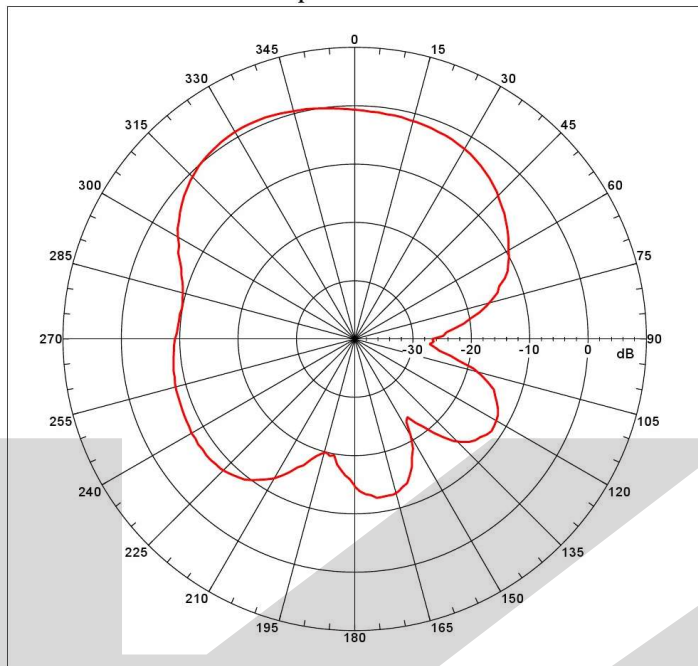

Far-field amplitude 1 900 MHz -H.nsi

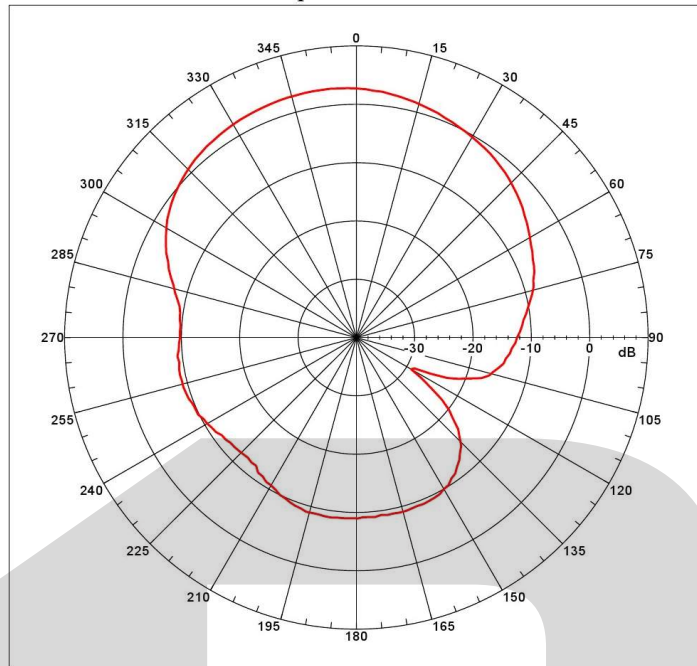

Far-field amplitude 2 100 MHz -E.nsi

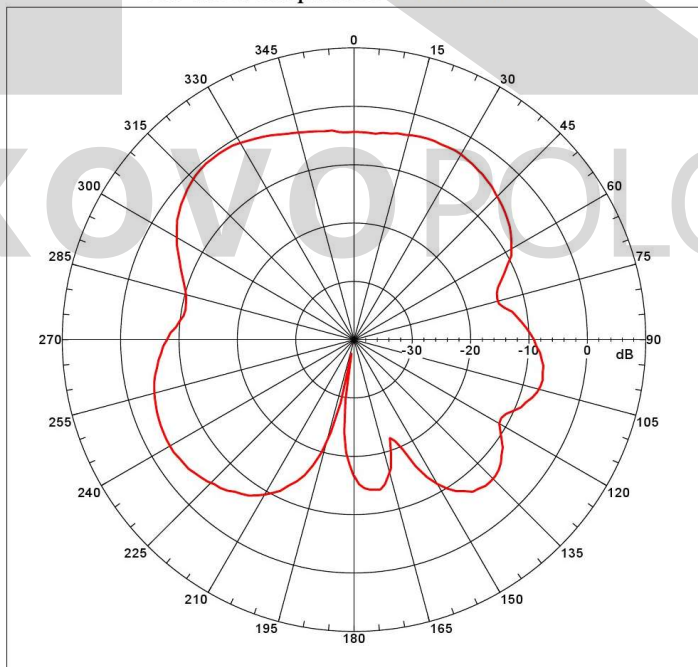

Far-field amplitude 2 100 MHz -H.nsi

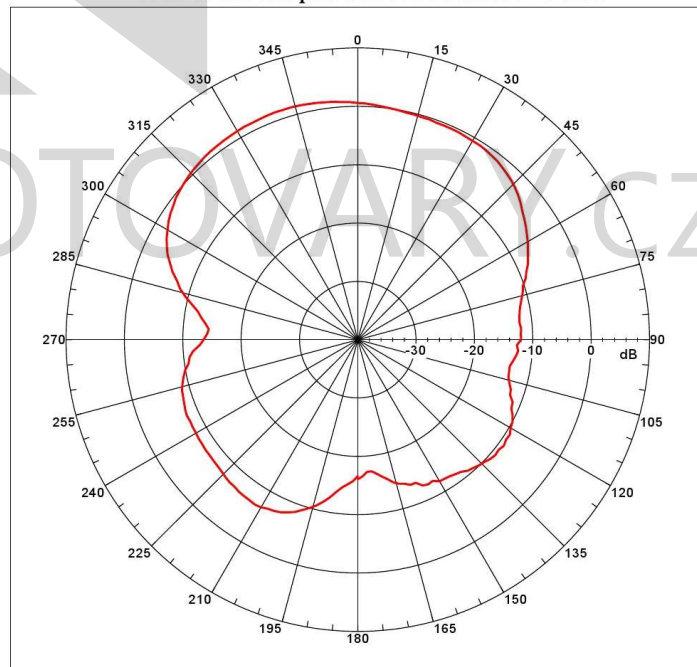

Different connector variants or cable lengths are available on request.



KOVOPOLOTOVARY.CZ